

LU-1500N Series

1-needle/2-needle, Unison-feed, Lockstitch Machine with Vertical-axis Large Hook

[Gauge for standard]

LU-1508NS

LU-1508NH

(for extra heavy materials)

LU-1510N

(with automatic lubricating mechanism)

LU-1510N-7

(with automatic lubricating mechanism and automatic thread trimmer)

[Gauge for LU-2200]

LU-1509NS

LU-1509NH

(for extra heavy materials)

LU-1511N-7

(with automatic lubricating mechanism and automatic thread trimmer)

2-needle, Unison-feed, Lockstitch Machine with Vertical-axis Large Hooks

[Gauge for standard]

LU-1560N

(with automatic lubricating mechanism)

LU-1560N-7

(with automatic lubricating mechanism and automatic thread trimmer)

LU-1565N

(with organized split needle bar)

[Gauge for LU-2200]

LU-1561N

LU-1561N-7

(with automatic lubricating mechanism and automatic thread trimmer)



LU-1510N-7-OBBA/CP-180C

Instantaneous change-over device for the alternate vertical movement amount: **DL device**
Bobbin thread remaining amount detecting device: **AE-15**
Operation panel

Options

The basic machine and its outstanding response to the sewing of heavy materials.

JUKI's unique feed mechanism promises excellent efficiency of feed. In addition to the standard models of 1-needle and 2-needle machines, other models intended for special purposes are available, including models for extra heavy materials and one having a thread trimmer. The machine is applicable to an extended range of heavy materials for industrial use, such as cargo handling belts and containers, as well as those for general use, such as car seats, sofas and bags, thereby contributing to both improved quality and increased productivity.



LU-1560N-7-OBBA/CP-180C

A new feed mechanism with a rectangular feeding motion prevents stitch gathering.

- The new mechanism with a rectangular feeding motion promises consistent feed of materials of all thickness without stitch gathering.
- The lower orbit of the feed dog prevents the material from flopping and reduces operating noise and vibration.

Elliptical feed

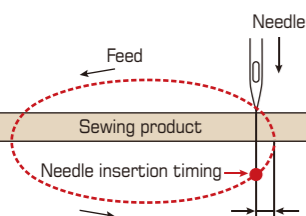

- The "needle" inserts into the fabric during the returning motion, which is likely to produce gathered stitches.

Conventional machines

Rectangular feed

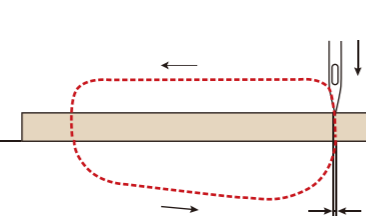

- Compared with the elliptical feed, the rectangular feed helps reduce gathered stitches.

LU-1508NS, LU-1510N, LU-1510N-7, LU-1560N, LU-1560N-7, LU-1565N, LU-1509NS, LU-1511N-7, LU-1561N, LU-1561N-7

Complete rectangular feed

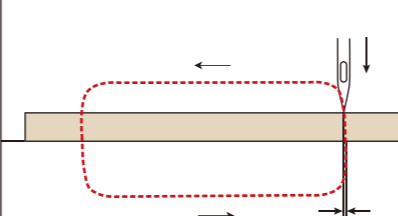

- The locus of the "needle" and "feed" motions are nearly rectangular. This prevents stitch gathering and provides efficient feed on multi-layered portions of material.

LU-1508NH, LU-1509NH

The alternating vertical movement mechanism prevents irregular stitches.

- The machine has adopted a new mechanism that does not change the ratio of alternate vertical movement of the walking foot and presser foot even when the material thickness changes.
- Even when a heavy-weight material is used, the presser foot lift does not decrease. This means that the presser foot comes into contact with the material at exactly the same time that it does when sewing lighter-weight sections of the material. As a result, the walking foot retains the material with a consistent pressure to prevent irregular stitches.
- The amount of the alternating vertical movement of the walking foot and presser foot can be adjusted up to the maximum of 6.5mm according to the height of multilayered portions of material.

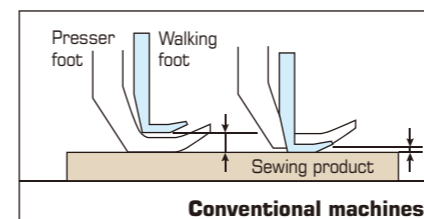

Conventional machines

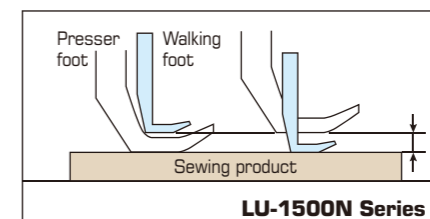

LU-1500N Series

The LU-2200 gauge type is a newly developed design.

- Machines with standard gauges and those with the LU-2200 gauge are available. Select either type according to your needs. (For LU-1565N model, only the standard gauge type is available.)



Gauge for standard



Gauge for LU-2200

Consistent seam quality.

- With the adoption of a new rectangular feed mechanism, an alternating vertical movement mechanism, and a unison feed mechanism, the machine can feed heavy materials powerfully and smoothly. Well tensed seams are consistently produced without pitch errors.
- With its maximum stitch length of 9mm, the machine can be applied to a broader range of uses.



(Piping holder is optionally available.)

Higher lift of the presser foot.

- The high, 16mm (13mm for LU-1565N) presser foot lift enables easy material handling.

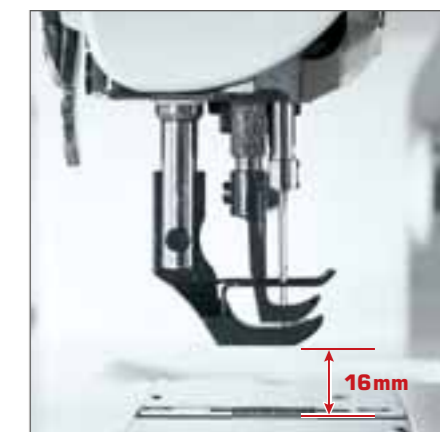

16mm

The highly efficient vertical-axis double-capacity hook is equipped as standard.

- With the adoption of this vertical-axis double-capacity hook, the frequency of bobbin thread changing is reduced, promising sewing work of increased efficiency.

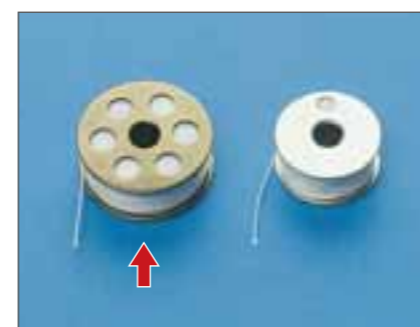

The machine comes with a dual-tension mechanism.

LU-1508NS, LU-1508NH, LU-1510N, LU-1510N-7, LU-1509NS, LU-1509NH, LU-1511N-7

- The 1-needle type machine has adopted a dual-tension mechanism, with which the machine can support high-tension sewing with thick thread. This means that the machine produces seams of excellent quality on a broader range of materials, extending from light- to heavy-weight.



LU-1508NS

1-needle, Unison-feed, Lockstitch machine with Vertical-axis Large Hook

LU-1508NS, LU-1509NS



- The standard 1-needle type machine that delivers the basic functions and performance best suited to the sewing of heavy materials.

LU-1508NH, LU-1509NH (for extra heavy materials)



(Suspended ruler: H152 is optionally available.)

- The maximum stitch length is 10mm. The complete rectangular feed locus enables accurate feed of extra heavy materials while preventing stitch gathering.
- With its sufficient needlebar stroke of 38mm and long 190R needle, the machine supports the sewing of extra heavy materials.
- The machine comes with an extra large steel handwheel with a diameter as large as $\phi 175$.

LU-1510N (with automatic lubricating mechanism)



- Automatic lubricating mechanism helps improve maintainability. The machine is provided with a sub oil pan and double filter to keep dust from entering the oil.
- The machine is equipped with a bottom-feed adjusting mechanism that adjusts the amount of bottom-feed while keeping the needle feed fixed. With this adjusting mechanism, the machine can prevent uneven material feed without changing stitch pitches.

2-needle, Unison-feed, Lockstitch machine with Vertical-axis Large Hooks

LU-1560N, LU-1561N (with automatic lubricating mechanism)



- The standard 2-needle type machine that delivers the basic functions and performance best suited to the sewing of heavy materials.
- Automatic lubricating mechanism improves maintainability. The sub oil pan and double filter prevent dust from entering the oil.

LU-1565N (with organized split needle bar)



- The organized split needle bar mechanism makes it possible to stop or reset the left or right needle by operating a one-touch utility lever. The machine produces neatly finished stitches at corner parts of the material.

Improved operability.

- The stitch length can be easily selected by the stitch dial.
- The machine is provided with many improved features that offer enhanced operability such as an easy-to-observe area around the needle, placement of the bobbin winder on the front face of the machine arm, and a large handwheel ($\phi 160$).
- A knee-lifter mechanism is built in the bed. This reduces the pressure required to operate the knee-lifter and facilitates setup. (Machines equipped with automatic thread trimmer are excluded.)
- The machine is full-open-type top design makes it possible to fully open the top of the machine arm. Thanks to this design, adjusting works can be done without tilting the machine head.
- The machine is equipped as standard with a safety clutch for preventing hook breakage. Reset work can be done simply by pressing a button.

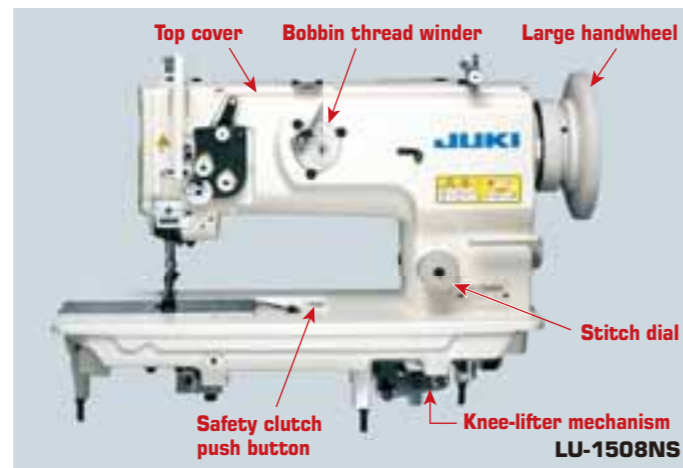

1-needle, Unison-feed, Lockstitch Machine with Vertical-axis Large Hook (and automatic lubricating mechanism and automatic thread trimmer)

LU-1510N-7, LU-1511N-7



LU-1510N-7-OBBA/CP-180C

2-needle, Unison-feed, Lockstitch Machine with Vertical-axis Large Hooks (and automatic lubricating mechanism and automatic thread trimmer)

LU-1560N-7, LU-1561N-7



LU-1560N-7-OBBA/CP-180C

Instantaneous change-over device for the alternate vertical movement amount: **DL device**
Bobbin thread remaining amount detecting device: **AE-10, AE-15**
Operation panel: **CP-180C**

Options

The area around the needle entry is designed to be easily observed.

- Since the needle thread tension-release solenoid is fitted on the rear face of the machine head, the area around the needle entry and one-touch type reverse feed button is easily viewable. This substantially contributes to improved operability.



The walking foot and presser foot's alternating vertical movement can be set and changed with ease.

- The vertical strokes of the presser foot and walking foot (their alternating vertical movement) can be easily changed using a large dial mounted on the top surface of the machine head.
- In addition the sewing speed is automatically adjusted with the set value. With this feature, ideal sewing conditions are maintained at all times.
- The machine is equipped with an instantaneous changeover device for alternating the vertical movement amount of the walking foot and presser foot, which demonstrates its capability for processes involving sewing products with a lot of multi-layered portions.



A helpful automatic reverse feed function is provided as standard.

- With just a light press on the one-touch type reverse feed button, reverse feed stitching is actuated. Furthermore if a suspended ruler is attached on the machine or a 3-dimensional sewing product is sewn, the button can be shifted upward to prevent interruption.
- The auto-lifter (pedal switch type) helps to increase efficiency by reducing operator fatigue.



Thread trimming without fail.

- The machine leaves a shorter needle thread after thread trimming, improving thread consumption efficiency. With a rigid knife and improved cam shape, the thread trimmer cuts thread as thick as #5 without fail.



Bottom-feed micro-adjustment mechanism is provided as standard. (LU-1510N-7, LU-1511N-7)

- The 1-needle type machine is equipped with a bottom-feed micro-adjustment mechanism with the needle feed amount fixed. This helps prevent irregular stitches which are free from pitch errors.

OPTIONS

For the machines without automatic thread trimmer
**LU-1508NS, LU-1508NH, LU-1510N, LU-1560N,
 LU-1565N, LU-1509NS, LU-1509NH, LU-1561N**

*These options are for SC-922.

● Pneumatic auto-lifter

Type	Part No.	Switch type		Air regulator	
		Knee switch type	Pedal switch type	Not provided	Provided
AK-147A	40103185	○	—	○	—
AK-147B	40103186	—	○	○	—
AK-147C	40103187	○	—	—	○
AK-147D	40103188	—	○	—	○

● Combination of optional devices

Combination	Pneumatic auto-lifter	Automatic reverse feed function
Automatic reverse feed function	—	○
Pneumatic auto-lifter	AK-147C	—
Pneumatic auto-lifter + Automatic reverse feed function	AK-147A	○
	AK-147B	○

● Automatic reverse feed function

Part No.	Remarks
40103190	Provided with air regulator

*To use auto-lifter and reverse feed stitching device in combination, select AK-147A or AK-147B.

*Excluding LU-1565N model.

For the machines with automatic thread trimmer
LU-1510N-7, LU-1560N-7, LU-1511N-7, LU-1561N-7

● Instantaneous change-over device for the alternate vertical movement amount (DL device).

Part No.	Remarks
40103193	[DL26 (C kit)] for installed after the setup of the machine

● For sewing processes that handle heavy materials or multi-layered parts of material, the alternating vertical movements of the walking foot and presser foot can be quickly set to maximum by pressing the DL switch. The result is beautiful seams free from gathered stitches.

● The machine is provided with both hand switch and knee switch.

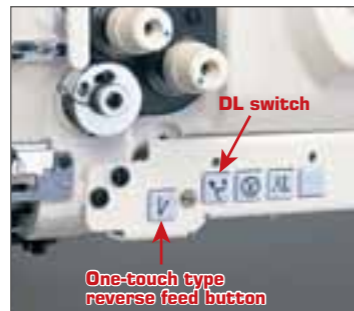

● Bobbin thread remaining amount detecting device: AE-10, AE-15

Part No.	Part name	Applicable models	Remarks
40102727	AE-15 (Kit A)	LU-1510N-7, LU-1511N-7	For installed after the setup of the machine
40102728	AE-15 (Kit B)	LU-1560N-7, LU-1561N-7	

● The bobbin thread remaining-amount detecting device warns the operator with a buzzing sound and lamp indication of the time for bobbin thread replacement. This allows the operator to concentrate on sewing work without concern for the remaining amount of bobbin thread. Since the device directly detects the bobbin thread amount remaining, cumbersome setting is no longer required regardless of the material, thread and process.

*The AE-10 and AE-15 cannot be attached to the conventional LU-1510-7 and LU-1560-7 models.

● 3-pedal unit PK75 Part No.: GPK-750000AO

● Highly operable 3-pedal unit for standing work.



● Suspended ruler H152

Part No.	Parts names
MAH-152010AO	Suspended ruler (asm.)
SS-7151610SP×2	Screw
WP-0621016SD×2	Washer
WS-0610002KN×2	Spring washer



● Piping holder (for 1-needle machines)

Part No.	Core dia. (mm)
MAY-BL6B10AO	6~10
MAY-BL6B20AO	2~5



WHEN YOU PLACE ORDERS

Gauge for standard

● Machine head

1-needle (without automatic thread trimmer)
LU1508N LU1510N

Application	Code
Heavy-weight	S
Extra heavy-weight	H

Pneumatic auto-lifter	Code
Pedal switch type (AK-147B)	B

1-needle (with automatic thread trimmer)
LU1510N70BB

DL device	Code
Not provided	Z
Provided	A

Option	Code
Not provided	Z
AE-15 (Bobbin thread remaining amount detecting device)	A

2-needle (without automatic thread trimmer)

Needle gauge	Code
4.8mm (3/16")	D
6.4mm (1/4")	F
7.9mm (5/16")	H
9.5mm (3/8")	K
12.7mm (1/2")	L

Needle gauge	Code
4.8mm (3/16")	D
6.4mm (1/4")	F
7.9mm (5/16")	H

2-needle (with automatic thread trimmer)

Needle gauge	Code
4.8mm (3/16")	D
6.4mm (1/4")	F
7.9mm (5/16")	H
9.5mm (3/8")	K
12.7mm (1/2")	L

Pneumatic auto-lifter	Code
Pedal switch type (AK-147B)	B

LU1560N LU1565N

Presser foot	Code
Standard	S
Center guide	A*

*For the gauge groups H, K and L only, the presser foot group A (equipped with center guide) can be selected.

LU1560N 70BB

DL device	Code
Not provided	Z
Provided	A

Option	Code
Not provided	Z
AE-15 (Bobbin thread remaining amount detecting device)	A

— Needle gauge correspondence table —

(1) The needle gauges marked with a circle (○) in the table below are prepared as optional parts (separately available).
 (2) The needle gauges marked with a circle (◐) are selectable at the time the order is placed.

● LU-1560N Series

Model name	Needle gauge	3.2mm (1/8")	4.8mm (3/16")	6.4mm (1/4")	7.9mm (5/16")	9.5mm (3/8")	12.7mm (1/2")	15.9mm (5/8")	19.1mm (3/4")	22.2mm (7/8")	25.4mm (1")	28.6mm (1-1/8")	31.8mm (1-1/4")
LU-1560N	Code	—	D	F	H	K	L	—	—	—	—	—	—
LU-1560N-7		○	◐	○	○	○	○	○	○	○	○	○	○
LU-1565N		—	○	○	○	○	○	—	—	—	—	—	—

Gauge for LU-2200

● Machine head

1-needle (without automatic thread trimmer)
LU1509N

Application	Code
Heavy-weight	S
Extra heavy-weight	H

Pneumatic auto-lifter	Code
Pedal switch type (AK-147B)	B

1-needle (with automatic thread trimmer)
LU1511N70BB

DL device	Code
Not provided	Z
Provided	A

Option	Code
Not provided	Z
AE-15 (Bobbin thread remaining amount detecting device)	A

2-needle (without automatic thread trimmer)
LU1561N

Needle gauge	Code
6mm	B
8mm	C
10mm	D
12mm	E

2-needle (with automatic thread trimmer)

Pneumatic auto-lifter	Code
Pedal switch type (AK-147B)	B

LU1561N 70BB

DL device	Code
Not provided	Z
Provided	A

Option	Code
Not provided	Z
AE-15 (Bobbin thread remaining amount detecting device)	A

— Needle gauge correspondence table —

(1) The needle gauges marked with a circle (○) in the table below are prepared as optional parts (separately available).
 (2) The needle gauges marked with a circle (◐) are selectable at the time the order is placed.

● LU-1561N Series

Model name	Needle gauge	4mm	6mm	8mm	10mm	12mm	14mm	16mm	18mm	20mm	22mm	24mm	26mm	30mm
LU-1561N	Code	—	B	C	D	E	—	—	—	—	—	—	—	—
LU-1561N-7		○	○	○	○	○	○	○	○	○	○	○	○	○

● Control box SC922A

Power supply	Code
Single-phase 100~120V	S
3-phase 200~240V	D
Single-phase 200~240V (for General Export)	K
Single-phase 200~240V (for CE)	N

● Motor for SC M51N

● Panel CP18C CP180C

● Control box SC922A

Power supply	Code
Single-phase 100~120V	S
3-phase 200~240V	D
Single-phase 200~240V (for General Export)	K
Single-phase 200~240V (for CE)	N

● Motor for SC M51N

● Panel CP18C CP180C

SPECIFICATIONS

I1-needle, Unison-feed, Lockstitch Machine with Vertical-axis Large Hook

Model name	LU-1508NS, LU-1509NS	LU-1508NH, LU-1509NH	LU-1510N	LU-1510N-7, LU-1511N-7
	—		—	With automatic thread trimmer
Application	Heavy-weight	Extra heavy-weight	Heavy-weight	
Max. sewing speed	2,500sti/min*		2,500sti/min*	3,000sti/min*
Max. stitch length	9mm (forward/backward)		9mm (forward/backward)	
Needle bar stroke	36mm		36mm	
Lift of the presser foot	By hand: 9mm, By knee: 16mm (max.)			By hand: 9mm, Auto: 16mm
Auto-lifter	Option			Provided as standard (pneumatic auto-lifter: AK-147B)
Alternating vertical movement	2.5~6.5mm			1~6.5mm
Dial for adjustment of alternating vertical movement	—			Provided as standard
Thread take-up	Slide type			
Hook	Vertical-axis double-capacity hook			
Needle (at the time of delivery)	135×17 (Nm160) Nm125~Nm180	Standard 190R or 135×17 (Nm160) Nm125~Nm200	135×17 (Nm160) Nm125~Nm180	
Thread	#30~#5, B46~B138, Nm=60/3~20/3	#20~#1, B69~B207, Nm=40/3~8/3	#30~#5, B46~B138, Nm=60/3~20/3	
Locus of feed	Rectangular feed	Complete rectangular feed	Rectangular feed	
Needle thread tension box	Dual-tension method			
Bottom-feed micro-adjustment mechanism	—			Provided as standard
Pitch changing method	By dial			
Bobbin thread winder	Built on the machine head			
Knee-lifter mechanism	Built on the machine head			—
Safety mechanism	Provided as standard (reset with the push of a button)			
Lubrication	Centralized oil wick lubrication (hook: automatic)		Automatic	
Lubricating oil	JUKI New Defrix Oil No.2 (equivalent to ISO VG32)			
Distance from needle to machine arm	255mm			
Bed size	517mm×178mm			
Weight of the machine head	42.5kg	44.5kg	43kg	48kg
Automatic reverse feed function	Option			Provided as standard
Compressed air and air consumption	—			0.5MPa {5kg/cm ² } • 0.3Nℓ/min
Power requirement	—			Single-phase 100~120V, 220~240V 3-phase 200~220V, 220~240V
Power consumption	—			550VA

I2-needle, Unison-feed, Lockstitch Machine with Vertical-axis Large Hooks

Model name	LU-1560N	LU-1561N	LU-1560N-7	LU-1561N-7	LU-1565N
	—		With automatic thread trimmer		With organized split needle bar
Application	Heavy-weight				
Max. sewing speed	2,500sti/min*				2,000sti/min*
Max. stitch length	9mm (forward/backward)				
Needle bar stroke	36mm			33.4mm	
Lift of the presser foot	By hand: 9mm, By knee: 16mm (max.)		By hand: 9mm, Auto: 16mm		By hand: 9mm, By knee: 13mm (max.)
Auto-lifter	Option		Provided as standard (pneumatic auto-lifter: AK-147B)		Option
Needle gauge	4.8mm, 6.4mm, 7.9mm, 9.5mm, 12.7mm (3/16, 1/4, 5/16, 3/8, 1/2)	6mm, 8mm, 10mm, 12mm	4.8mm, 6.4mm, 7.9mm, 9.5mm, 12.7mm (3/16, 1/4, 5/16, 3/8, 1/2)	6mm, 8mm, 10mm, 12mm	4.8mm, 6.4mm, 7.9mm (3/16, 1/4, 5/16)
Organized split needle bar	—				Provided as standard
Alternating vertical movement	2.5~6.5mm		1~6.5mm		2.5~6.5mm
Dial for adjustment of alternating vertical movement	—		Provided as standard		—
Thread take-up	Slide type				
Hook	Vertical-axis double-capacity hook				
Needle (at the time of delivery)	135×17 (Nm160) Nm125~Nm180				
Thread	#30~#5, B46~B138, Nm=60/3~20/3				
Locus of feed	Rectangular feed				
Needle thread tension box	Single-tension method				
Pitch changing method	By dial				
Bobbin thread winder	Built on the machine head				
Knee-lifter mechanism	Built on the machine head		—		Built on the machine head
Safety mechanism	Provided as standard (reset with the push of a button)				
Lubrication	Automatic				By an oiler (hook: automatic)
Lubricating oil	JUKI New Defrix Oil No.2 (equivalent to ISO VG32)				
Distance from needle to machine arm	255mm				
Bed size	517mm×178mm				
Weight of the machine head	45kg	51kg			45kg
Automatic reverse feed function	Option		Provided as standard		—
Compressed air and air consumption	—		0.5MPa {5kg/cm ² } • 0.3Nℓ/min		—
Power requirement	—		Single-phase 100~120V, 220~240V 3-phase 200~220V, 220~240V		—
Power consumption	—		550VA		—

*sti/min" stands for "Stitches per Minute."

● To order, please contact your nearest JUKI distributor.



Registered Organization: JUKI CORPORATION Head Office
The Scope of the Registration: The activities of research, development, design, sales, distribution, and maintenance services of industrial sewing machines, household sewing machines and industrial robots, etc., including sales and maintenance services of data entry systems.

JUKI

JUKI CORPORATION
SEWING MACHINERY BUSINESS UNIT

2-11-1, TSURUMAKI, TAMA-SHI,
TOKYO 206-8551, JAPAN
PHONE : (81) 42-357-2254
FAX : (81) 42-357-2274
http://www.juki.com

* Specifications and appearance are subject to change without prior notice for improvement.
* Read the instruction manual before putting the machine into service to ensure safety.
* This catalogue prints with environment-friendly soyink on recycle paper.